

# GaAs IR Emitting Diodes in Hermetically Sealed TO18 Case

## Description

TSTS710. series are infrared emitting diodes in standard GaAs technology in a hermetically sealed TO-18 package. Their glass lenses provide a very high radiant intensity without external optics.

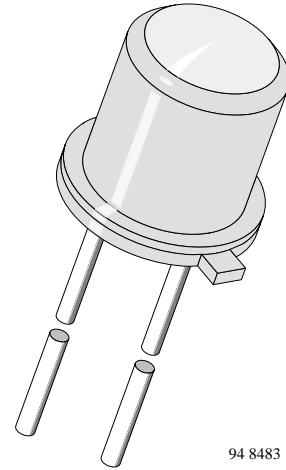

94 8483

## Features

- Very high radiant intensity
- Suitable for pulse operation
- Narrow angle of half intensity  $\varphi = \pm 5^\circ$
- Peak wavelength  $\lambda_p = 950 \text{ nm}$
- High reliability
- Good spectral matching to Si photodetectors

## Applications

Radiation source in near infrared range

## Absolute Maximum Ratings

$T_{amb} = 25^\circ\text{C}$

| Parameter                           | Test Conditions   | Symbol     | Value      | Unit             |
|-------------------------------------|---|------------|------------|------------------|
| Reverse Voltage                     |   | $V_R$      | 5          | V                |
| Forward Current                     | $T_{case} \leq 25^\circ\text{C}$  | $I_F$      | 250        | mA               |
| Peak Forward Current                | $t_p/T = 0.5, t_p \leq 100 \mu\text{s}, T_{case} \leq 25^\circ\text{C}$ | $I_{FM}$   | 500        | mA               |
| Surge Forward Current               | $t_p \leq 100 \mu\text{s}$  | $I_{FSM}$  | 2.5        | A                |
| Power Dissipation                   |   | $P_V$      | 170        | mW               |
|                                     | $T_{case} \leq 25^\circ\text{C}$  | $P_V$      | 500        | mW               |
| Junction Temperature                |   | $T_j$      | 100        | $^\circ\text{C}$ |
| Storage Temperature Range           |   | $T_{stg}$  | -55...+100 | $^\circ\text{C}$ |
| Thermal Resistance Junction/Ambient |   | $R_{thJA}$ | 450        | K/W              |
| Thermal Resistance Junction/Case    |   | $R_{thJC}$ | 150        | K/W              |

### Basic Characteristics

$T_{amb} = 25^{\circ}\text{C}$

| Parameter                     | Test Conditions   | Symbol          | Min | Typ     | Max | Unit |
|-------------------------------|---|-----------------|-----|---------|-----|------|
| Forward Voltage               | $I_F = 100\text{ mA}$ , $t_p \leq 20\text{ ms}$                             | $V_F$           |     | 1.3     | 1.7 | V    |
| Breakdown Voltage             | $I_R = 100\text{ }\mu\text{A}$  | $V_{(BR)}$      | 5   |         |     | V    |
| Junction Capacitance          | $V_R = 0\text{ V}$ , $f = 1\text{ MHz}$ , $E = 0$                           | $C_j$           |     | 30      |     | pF   |
| Radiant Power                 | $I_F = 100\text{ mA}$ , $t_p \leq 20\text{ ms}$                             | $\phi_e$        |     | 7       |     | mW   |
| Temp. Coefficient of $\phi_e$ | $I_F = 100\text{ mA}$   | $TK_{\phi_e}$   |     | -0.8    |     | %/K  |
| Angle of Half Intensity       |   | $\varphi$       |     | $\pm 5$ |     | deg  |
| Peak Wavelength               | $I_F = 100\text{ mA}$   | $\lambda_p$     |     | 950     |     | nm   |
| Spectral Bandwidth            | $I_F = 100\text{ mA}$   | $\Delta\lambda$ |     | 50      |     | nm   |
| Rise Time                     | $I_F = 1.5\text{ A}$ , $t_p/T = 0.01$ ,<br>$t_p \leq 10\text{ }\mu\text{s}$ | $t_r$           |     | 400     |     | ns   |
| Fall Time                     | $I_F = 1.5\text{ A}$ , $t_p/T = 0.01$ ,<br>$t_p \leq 10\text{ }\mu\text{s}$ | $t_f$           |     | 400     |     | ns   |

### Type Dedicated Characteristics

$T_{amb} = 25^{\circ}\text{C}$

| Parameter         | Test Conditions                        | Type     | Symbol | Min  | Typ | Max | Unit  |
|-------------------|--|----------|--------|------|-----|-----|-------|
| Radiant Intensity | $I_F=100\text{mA}$ , $t_p=20\text{ms}$ | TSTS7100 | $I_e$  | 10   |     |     | mW/sr |
|                   |  | TSTS7101 | $I_e$  | 12.5 |     | 25  | mW/sr |
|                   |  | TSTS7102 | $I_e$  | 20   |     | 40  | mW/sr |
|                   |  | TSTS7103 | $I_e$  | 32   |     | 64  | mW/sr |

### Typical Characteristics ( $T_{amb} = 25^{\circ}\text{C}$ unless otherwise specified)

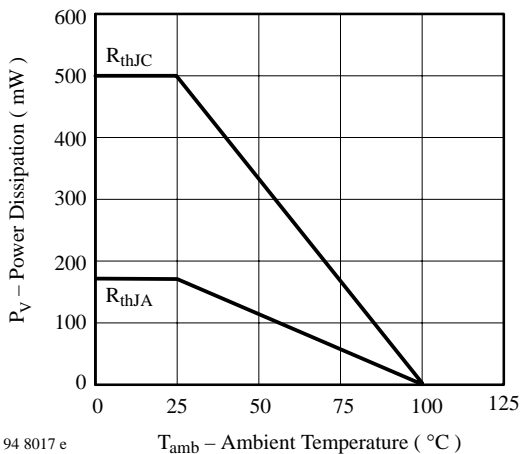

Figure 1. Power Dissipation vs. Ambient Temperature

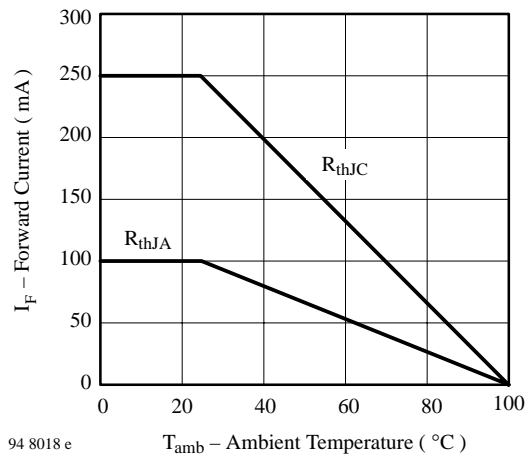
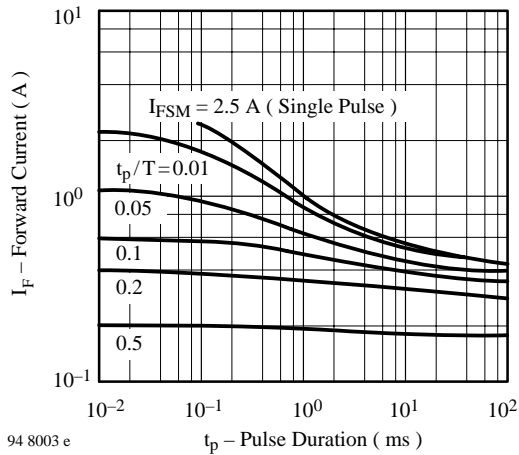
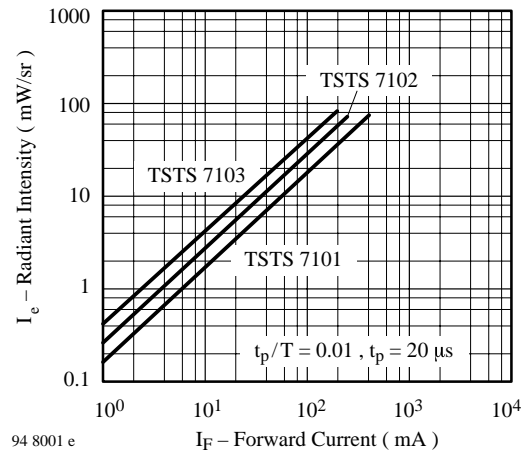

Figure 2. Forward Current vs. Ambient Temperature



94 8003 e

Figure 3. Pulse Forward Current vs. Pulse Duration



94 8001 e

Figure 6. Radiant Intensity vs. Forward Current

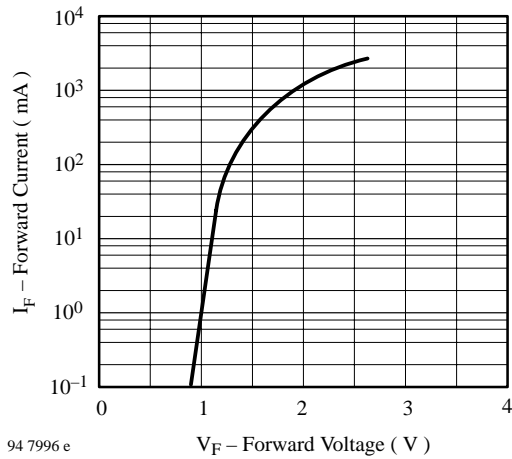

94 7996 e

Figure 4. Forward Current vs. Forward Voltage

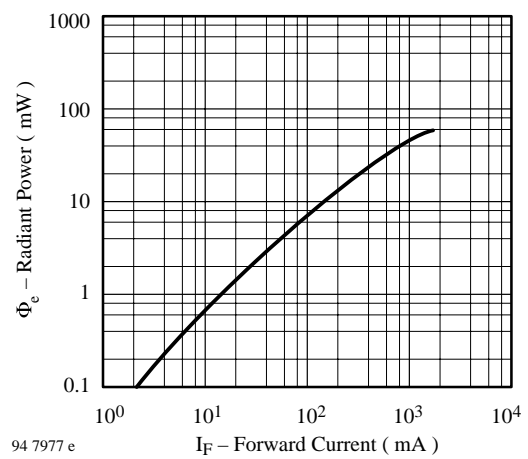

94 7977 e

Figure 7. Radiant Power vs. Forward Current

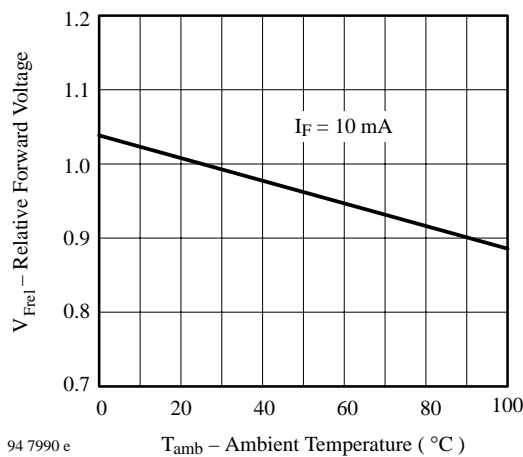

94 7990 e

Figure 5. Relative Forward Voltage vs. Ambient Temperature

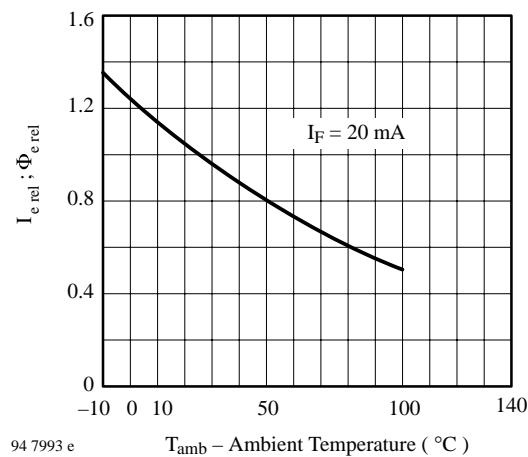

94 7993 e

Figure 8. Rel. Radiant Intensity/Power vs. Ambient Temperature

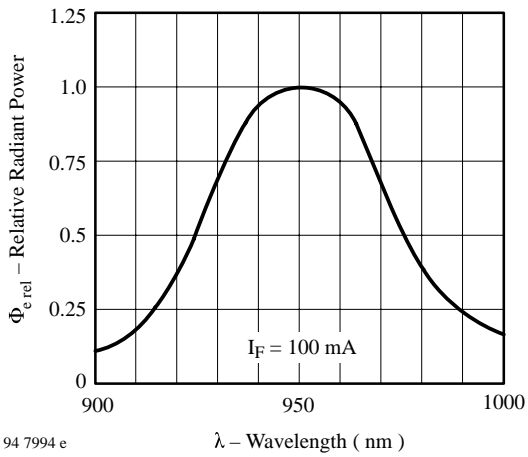

Figure 9. Relative Radiant Power vs. Wavelength

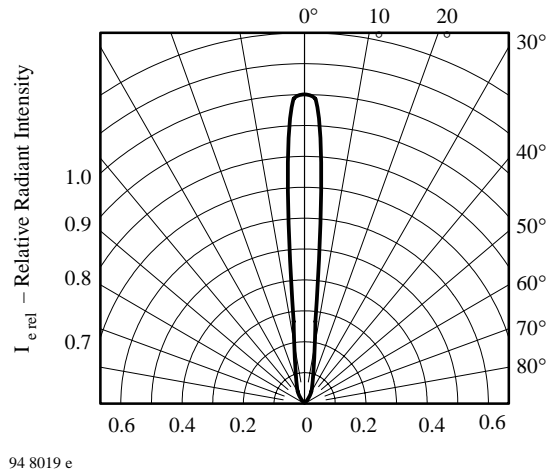
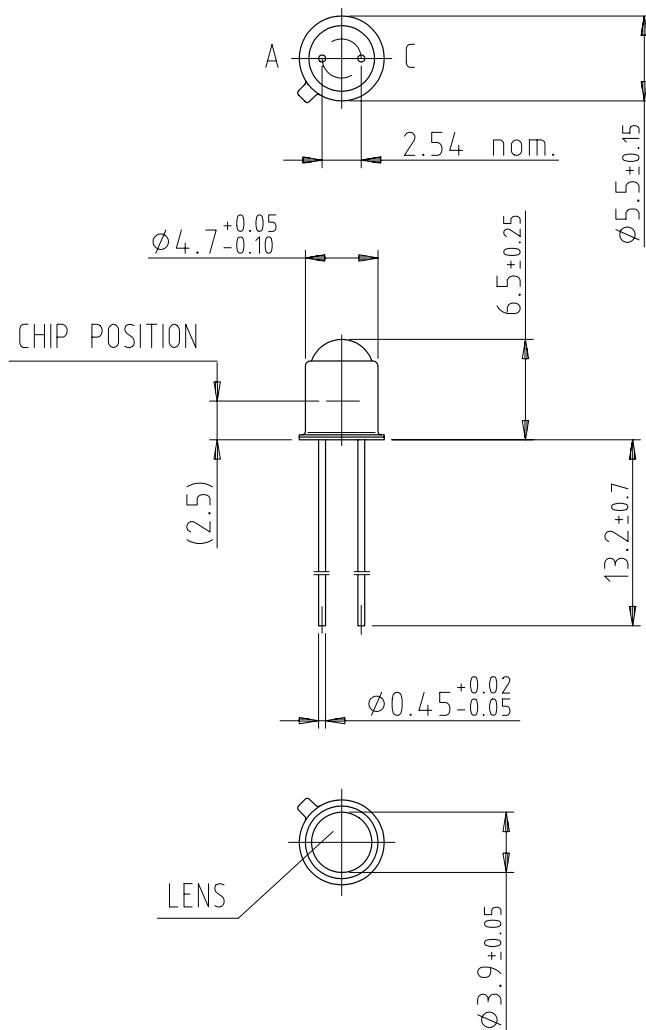

Figure 10. Relative Radiant Intensity vs. Angular Displacement

### Dimensions in mm



14486  
  
 technical drawings  
 according to DIN  
 specifications



## **Ozone Depleting Substances Policy Statement**

It is the policy of **Vishay Semiconductor GmbH** to

1. Meet all present and future national and international statutory requirements.
2. Regularly and continuously improve the performance of our products, processes, distribution and operating systems with respect to their impact on the health and safety of our employees and the public, as well as their impact on the environment.

It is particular concern to control or eliminate releases of those substances into the atmosphere which are known as ozone depleting substances (ODSs).

The Montreal Protocol (1987) and its London Amendments (1990) intend to severely restrict the use of ODSs and forbid their use within the next ten years. Various national and international initiatives are pressing for an earlier ban on these substances.

**Vishay Semiconductor GmbH** has been able to use its policy of continuous improvements to eliminate the use of ODSs listed in the following documents.

1. Annex A, B and list of transitional substances of the Montreal Protocol and the London Amendments respectively
2. Class I and II ozone depleting substances in the Clean Air Act Amendments of 1990 by the Environmental Protection Agency (EPA) in the USA
3. Council Decision 88/540/EEC and 91/690/EEC Annex A, B and C (transitional substances) respectively.

**Vishay Semiconductor GmbH** can certify that our semiconductors are not manufactured with ozone depleting substances and do not contain such substances.

**We reserve the right to make changes to improve technical design and may do so without further notice.**

Parameters can vary in different applications. All operating parameters must be validated for each customer application by the customer. Should the buyer use Vishay-Telefunken products for any unintended or unauthorized application, the buyer shall indemnify Vishay-Telefunken against all claims, costs, damages, and expenses, arising out of, directly or indirectly, any claim of personal damage, injury or death associated with such unintended or unauthorized use.

Vishay Semiconductor GmbH, P.O.B. 3535, D-74025 Heilbronn, Germany  
Telephone: 49 (0)7131 67 2831, Fax number: 49 (0)7131 67 2423