

AC Solid State Relay

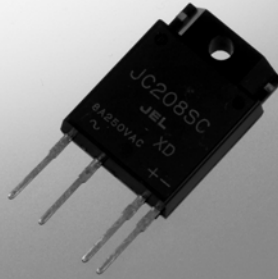

JC

SERIES



Features

Resin casted molding package with heat insulation board
Dielectric strength (Viso) between input and output 4,000Vrms

Conforms to Electrical Appliance Resistration System (For the unit with over 3.0mm distance between AC lines)

Type Information

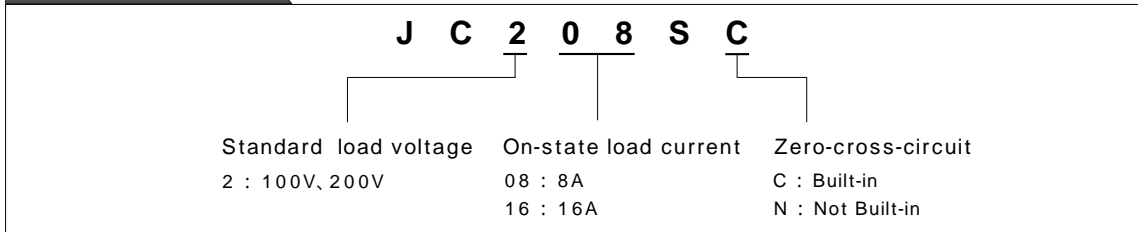

Characteristics

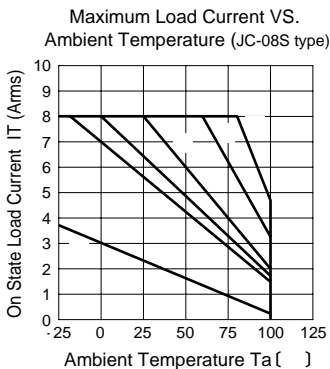

- | | |
|------------------------------|----------------------------|
| With infinite heat sink | With heat-sink plate |
| With heat-sink plate | (A1 plate 75 x 75 x 2mm) |
| (A1 plate 200 x 200 x 2mm) | With heat-sink plate |
| With heat-sink plate | (A1 plate 50 x 50 x 2mm) |
| (A1 plate 100 x 100 x 2mm) | No-heat-sink plate |

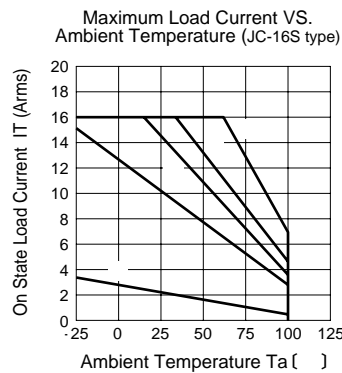

- | | |
|------------------------------|------------------------------|
| With infinite heat sink | With heat-sink plate |
| With heat-sink plate | (A1 plate 100 x 100 x 2mm) |
| (A1 plate 280 x 280 x 2mm) | No-heat-sink plate |
| With heat-sink plate | |
| (A1 plate 200 x 200 x 2mm) | |

Description in the catalogue is subject to change without notice. Please read the specifications thoroughly before using. Please contact JEL SYSTEM for further information.

Dimensions (mm)

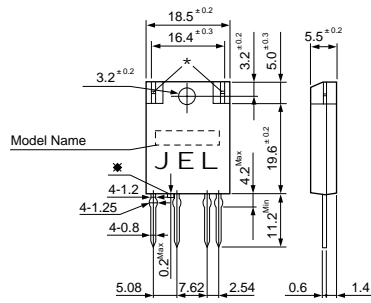

Caution
Use insulation board whenever
it is necessary

Output(AC) Input(+)
Output(AC) Input(-)

* Marked metal parts are not insulated with terminal .
* Marked parts are non-attachable to outer parts.

Equivalent Circuit

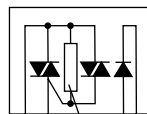

Zero-cross circuit
(Applicable to JC-SC Type)

Description in the catalogue is subject to change without notice. Please read the specifications thoroughly before using.
Please contact JEL SYSTEM for further information.

Absolute Maximum Ratings

(Ta = 25)

	Item	Symbols	JC208SN JC208SC	JC216SC	Units
Output	Rated Line Voltage		120、240		V _{ACrms}
	On State Load Current	I _T	8(Tc 80)*	16(Tc 60)*	A _{rms}
	Peak 1 Cycle Surge Current	I _{SURGE}	80	160	A
	Maximum Load Voltage	V _{OMAX}	280		V _{ACrms}
	Peak Repetitive Voltage	V _{DRM}	600		V
	Off State di/dt	di/dt	50		A/μm
	Frequency	f	50、60		Hz
Input	Forward Current	I _F	50		mA
	Reverse Voltage	V _R	6		V
General	Dielectric Strength	V _{ISO}	4,000 (Rh40 ~ 60 %、AC60Hz、1 min.)		V _{rms}
	Operating Temperature	T _{OPR}	- 25 ~ + 100		
	Storage Temperature	T _{STG}	- 30 ~ + 125		
	Soldering Temperature	T _{SOL}	260 (10 sec.)		

* TC ; case temperature

Electrical Characteristics

(Ta = 25)

	Item	Symbols	Condition	MIN	TYP	MAX	Units
Output	Load Voltage Range	V _O		35		280	V _{ACrms}
	Peak Repetitive Current	I _{DRM}	V _{DRM} = 600V			100	μA
	On State Voltage Drop	V _T	V _T = Rated、I _F = 20mA、Resistance load			1.5	V _{rms}
	Holding Current	I _H	V _D = 1 2·V _{DRM} (600V)			50	mA
	Off State dV/dt	dV/dt	V _D = 2/3·V _{DRM} (600V)	30			V/μs
	Commutation dV/dt	(dV/dt) _c	T _J = 125 、V _D = 400V、di/dt = *	5			V/μs
	Zero Cross Voltage (JC-SC)	V _{OX}	Resistance load、I _F = 8mA			35	V
Input	Forward Voltage	V _F	I _F = 20mA		1.2	1.4	V
	Reverse Current	I _R	V _R = 3V			100	μA
General	Minimum Trigger Current	I _{FT}	V _D = 6V、R _L = 30			15	mA
	Isolation Resistance	R _{ISO}	Rh40 ~ 60 %、DC500V	10 ¹⁰			
	Turn On Time	T _{ON}	JC208SN (JC208SC、JC216SC)			1 (10)	ms
	Turn Off Time	T _{OFF}				10	ms
	Thermal Resistance	R _{th} (j-a)			60		/W

* JC-08 Series ; di/dt = - 4.0/ms. JC-16Series ; di/dt = - 8.0/ms.

Description in the catalogue is subject to change without notice. Please read the specifications thoroughly before using.
Please contact JEL SYSTEM for further information.

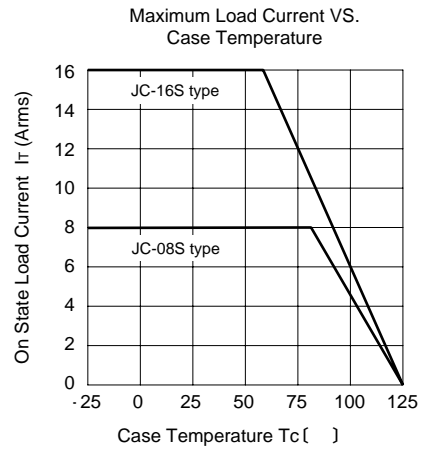
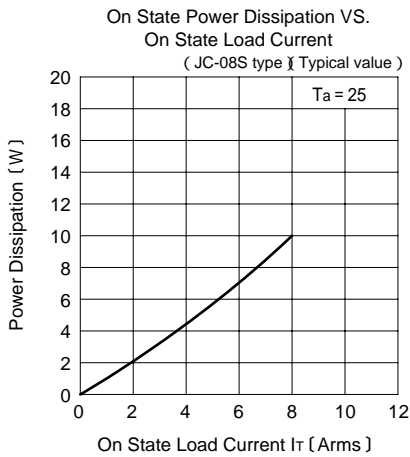
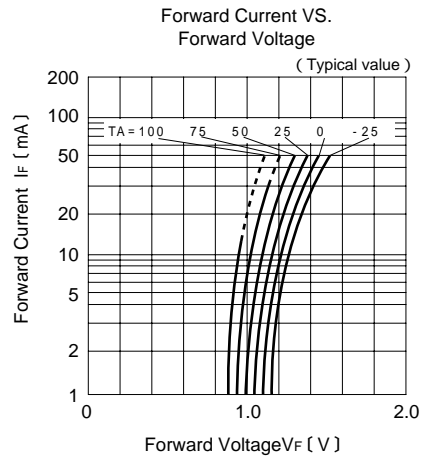
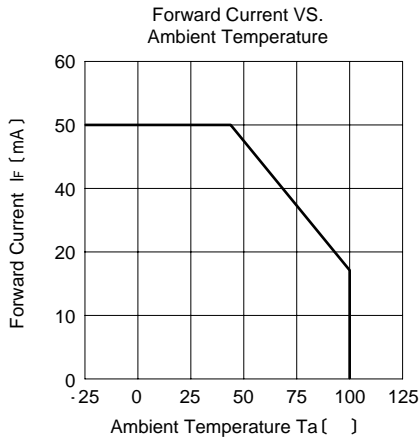

Description in the catalogue is subject to change without notice. Please read the specifications thoroughly before using. Please contact JEL SYSTEM for further information.

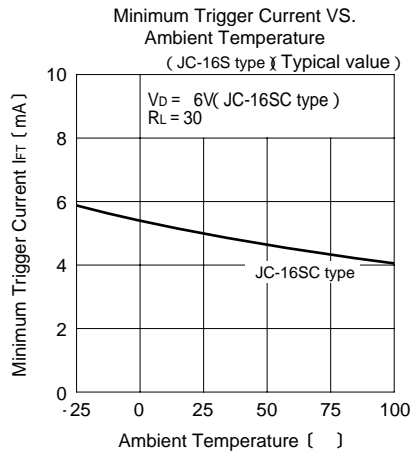
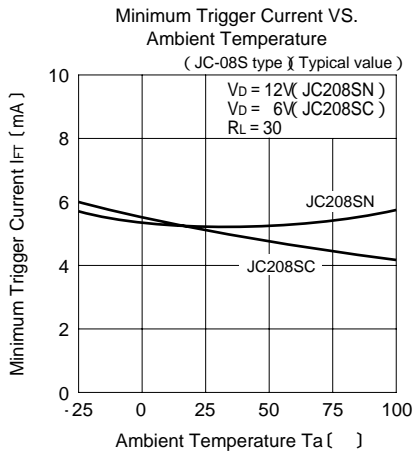
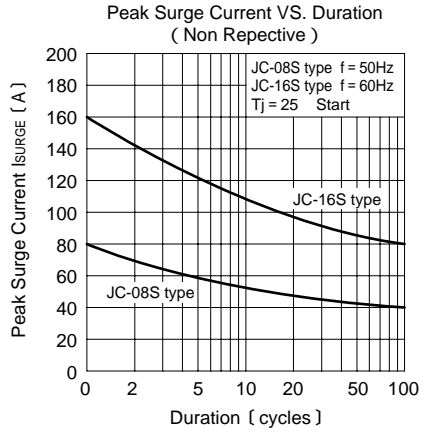
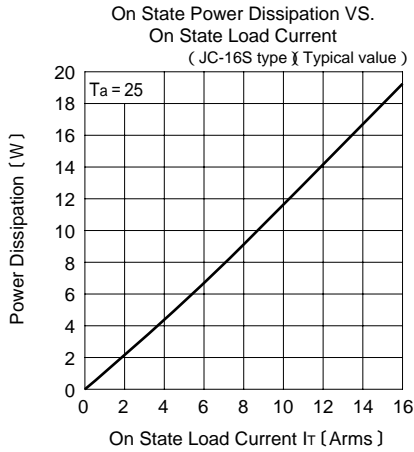

Description in the catalogue is subject to change without notice. Please read the specifications thoroughly before using.
Please contact JEL SYSTEM for further information.

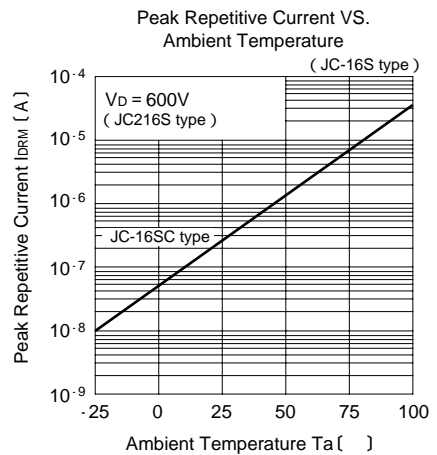
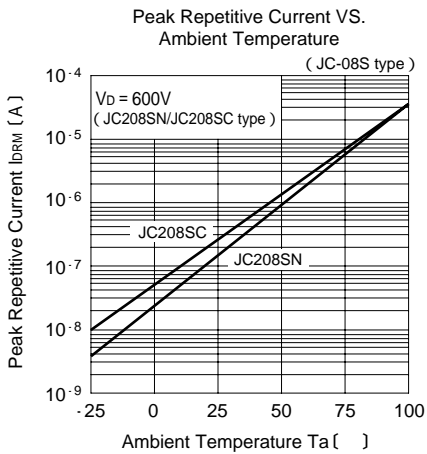
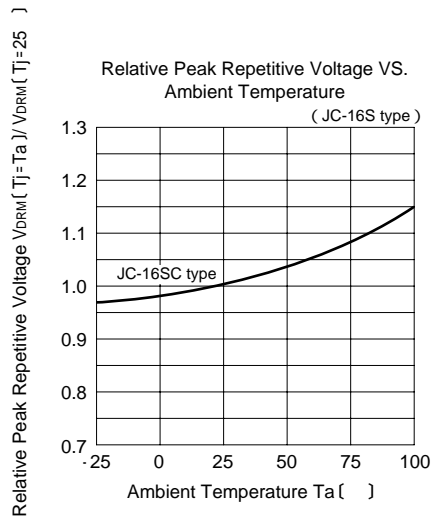
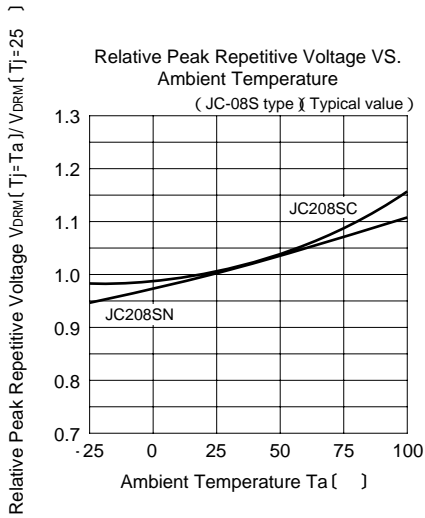

Description in the catalogue is subject to change without notice. Please read the specifications thoroughly before using.
Please contact JEL SYSTEM for further information.