



PRODUCT SPECIFICATION

Model No : CSM-57211S/CSM-57221S

Descriptions:
<ul style="list-style-type: none"> • 2.0Inch Dot-Matrix Display • 5*7 Array with X-Y Select. • CSM-57211: Column Anode, Row Cathode • CSM-57221: Column Cathode, Row Anode • Emitting Color: Super-Bright Red



CUSTOMER APPROVED SIGNATURES	APPROVED BY	CHECKED BY	PREPARED BY

CHINA SEMICONDUCTOR CORPORATION
 Address:2FL. NO.909,Chung-Cheng Road,
 Chung-Ho City Taipei Hsien,Taiwan.

Tel:886-2-2223-9696
 Fax:886-2-2223-9377

OPTO PLUS TECHNOLOGIES CO.,LTD

Address:696 Shun jiang Rd.,Ji Shan St.Shaoxing,
 ZheJiang,China

Tel:86-0575-88623888
 Fax:86-0575-88623112



Model No : CSM-57211S/CSM-57221S

■ **Features -**

1. 2.0 inch (50.7mm) Matrix height.
2. Case mold type.
3. RoHs compliant.
4. Low power consumption.
5. Easy mounting on P.C. board or socket.

■ **Device Selection Guide -**

Part No.	Chip		Description	
	Material	Emitted Color	Column	Row
CSM-57211S	AlGaAs	Super-Bright Red	Anode	Cathode
CSM-57221S			Cathode	Anode

■ **Package Dimensions -**

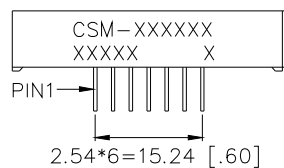
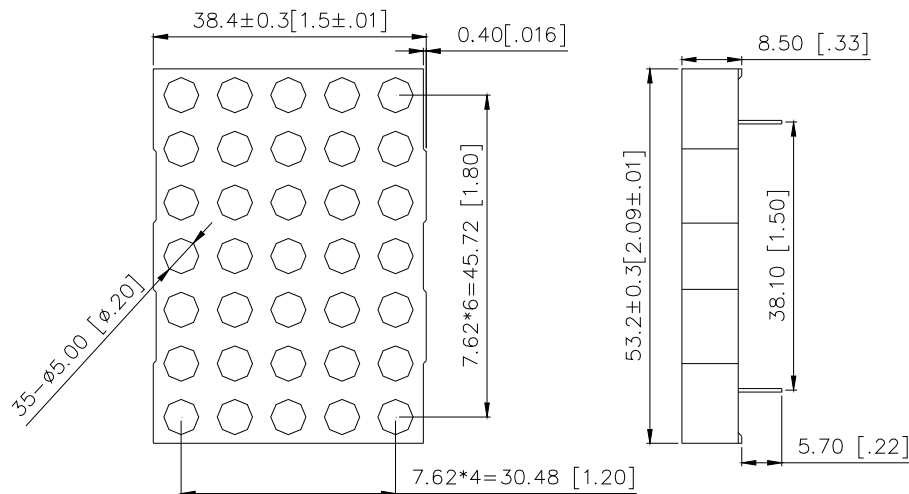

NOTE:

- 1 All pins are $\phi 0.5$ (.02).
- 2 All dimensions are in millimeters (inch), tolerance is ± 0.25 (.01) unless otherwise noted.



Model No : CSM-57211S/CSM-57221S

Internal Circuit Diagrams -

CSM-57211

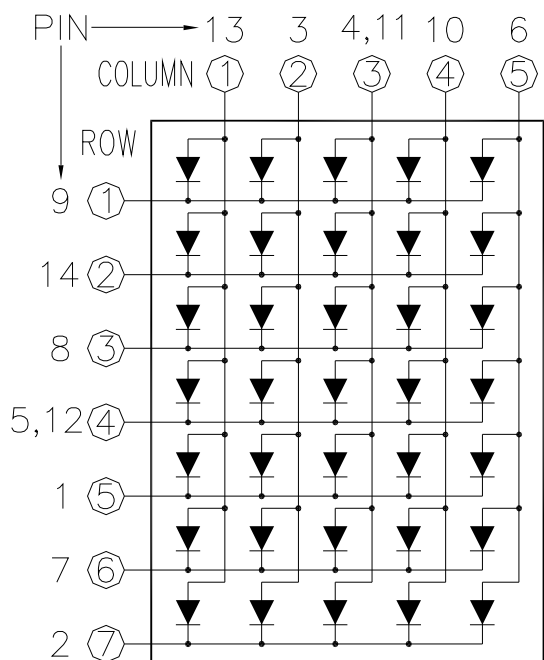

CSM-57221

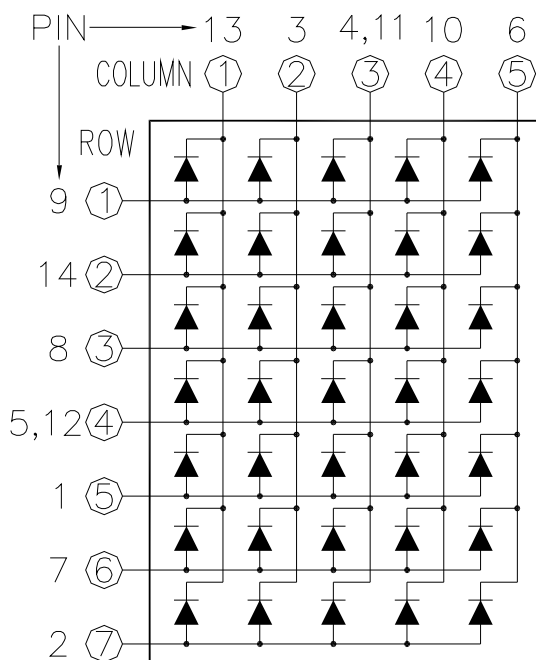

CSM-57211				CSM-57221			
PIN NO.	FUNCTION	PIN NO.	FUNCTION	PIN NO.	FUNCTION	PIN NO.	FUNCTION
1	Cathode Row 5	8	Cathode Row 3	1	Anode Row 5	8	Anode Row 3
2	Cathode Row 7	9	Cathode Row 1	2	Anode Row 7	9	Anode Row 1
3	Anode Column 2	10	Anode Column 4	3	Cathode Column 2	10	Cathode Column 4
4	Anode Column 3	11	Anode Column 3	4	Cathode Column 3	11	Cathode Column 3
5	Cathode Row 4	12	Cathode Row 4	5	Anode Row 4	12	Anode Row 4
6	Anode Column 5	13	Anode Column 1	6	Cathode Column 5	13	Cathode Column 1
7	Cathode Row 6	14	Cathode Row 2	7	Anode Row 6	14	Anode Row 2



Model No : CSM-57211S/CSM-57221S

■ Absolute Maximum Rating -

(Ta=25°C)

Parameter	Symbol	Rating	Unit
Power Dissipation Per Dice	P _{AD}	75	mW
Continuous Forward Current Per Dice	I _{AF}	30	mA
Peak Current Per Dice(duty cycle 1/10, 1kHz)	I _{PF}	120	mA
Derating Linear From 25°C Per Dice	-	0.42	mA/°C
Reverse Voltage Per Dice	V _R	5	V
Operating Temp.	T _{opr}	-35 ~ +85	°C
Storage Temp.	T _{stg}	-35 ~ +85	°C
Solder temperature 1/16 inch below seating plane for 3 seconds at 260°C			

■ Electro-optical Characteristics -

(Ta=25°C)

Parameter	Symbol	Min.	Typ.	Max.	Unit	Condition
Forward Voltage Per Segment	V _F	-	1.8	2.5	V	I _F =20mA
Luminous Intensity Per Segment	I _v	-	10	-	mcd	I _F =10mA
Peak Emission Wavelength	λ _p	-	660	-	nm	I _F =20mA
Dominant Wavelength	λ _d	-	644	-	nm	I _F =20mA
Spectrum Radiation Bandwidth	Δλ	-	20	-	nm	I _F =20mA
Reverse Current	I _R	-	-	100	μA	V _R =5V
Luminous Intensity Matching Ratio	I _{V-m}	-	-	2:1	-	I _p =80mA 1/16Duty



Model No : CSM-57211S/CSM-57221S

Typical Electrical / Optical Characteristics Curves -

(Ta = 25°C Unless Otherwise Noted)

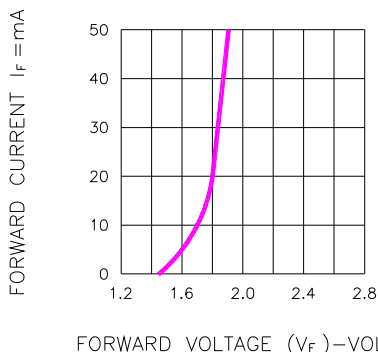

Fig.1 FORWARD CURRENT VS. FORWARD VOLTAGE

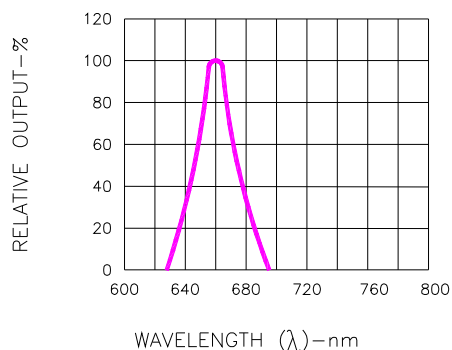

Fig.2 SPECTRAL RESPONSE

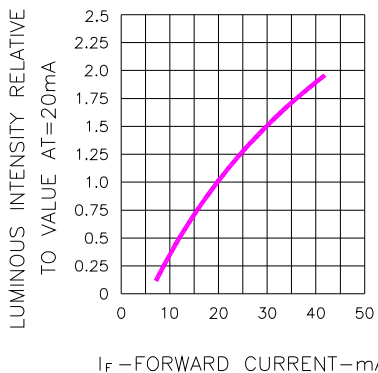

Fig.3 RELATIVE LUMINOUS INTENSITY VS. FORWARD CURRENT

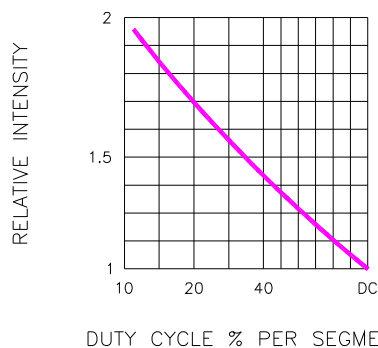

Fig.5 LUMINOUS INTENSITY VS. DUTY CYCLE

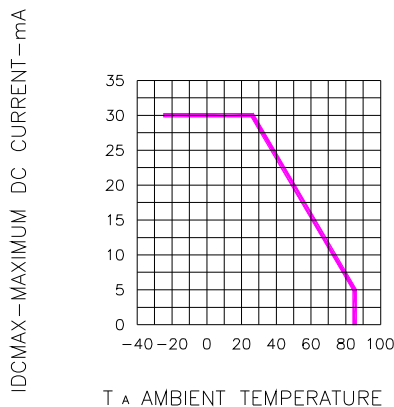

Fig.4 MAXIMUM ALLOWABLE DC CURRENT PER SEGMENT VS. A FUNCTION OF AMBIENT TEMPERATURE

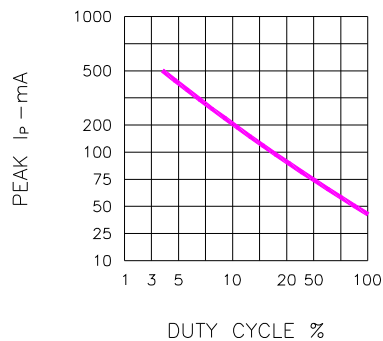
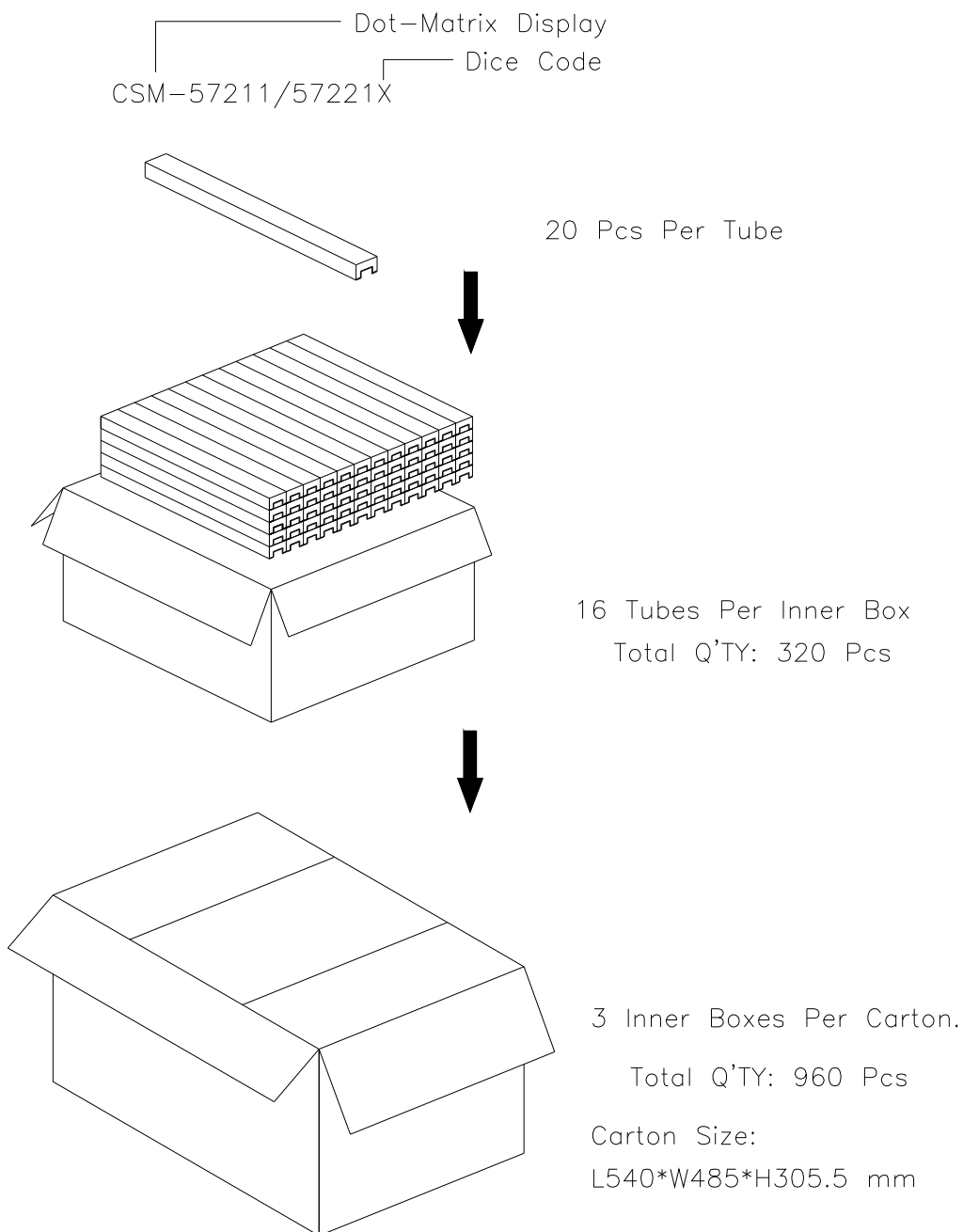

Fig.6 MAX PEAK CURRENT VS. DUTY CYCLE % (REFRESH RATE f=1 KHz)



Model No : CSM-57211S/CSM-57221S

■ Package Dimensions



Note: The specifications are subject to change without notice. Please contact us for updated information.